

IQAN Accessories

Electronic Control Systems



Prototype installation cables

5030025

C1-cable: 2,5 meters, fits to IQAN-XP, -XS
(-MDL2 with minor modification)

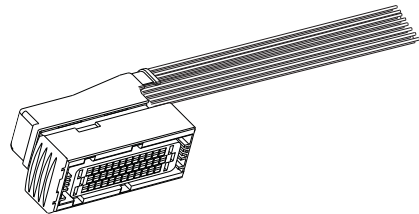

5030030

C1-cable: 2,5 meters, fits to IQAN-XP2, -XT2,
(-TOC8, -XA2, -XS2, -MC2 with minor modification)

5030029

IQAN-MDM-cable: 2,5 meters

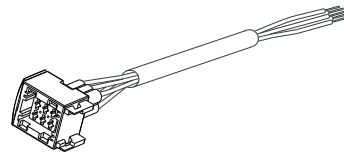

5030090

C1-cable: 2,5 meters, fits to IQAN-TOC2

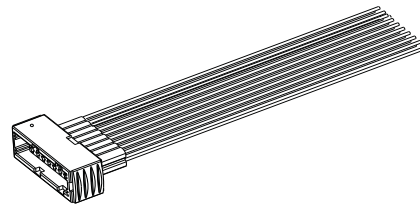

5030094

4 pin JPT: 2,5 meters, fits to IQAN-LSL, -LST

5030095

2 pin JPT: 2,5 meters, fits to IQAN-LSL

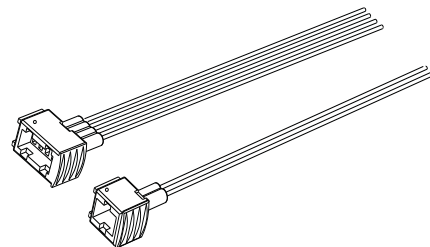

ENGINEERING YOUR SUCCESS.

Prototype installation cables

5030125

C1-cable: 2,5 meters, fits to IQAN-MD3, -G1, -LC5-C0x; Grey, key A
(-MD3 for power, clock, CAN and RS232; -G1 for power and RS232; -LC5 for external I/O)

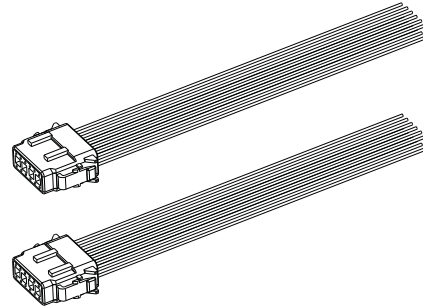

5030126

C2-cable: 2,5 meters, fits to IQAN-MD3
Black, key B (for inputs, output, USB and VREF)

5030127

C1-cable: 2,5 meters, fits to IQAN-LC5-X05, -LC5-C0x

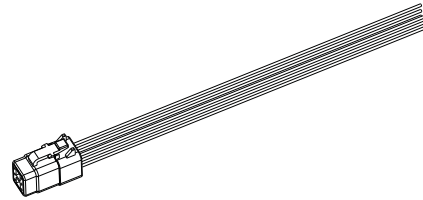

5030216

C1-cable: 2,5 meters, fits to IQAN-MC3
Black, key A (for power, CAN and outputs)

5030217

C2-cable: 2,5 meters, fits to IQAN-MC3
Black, key B (for inputs and VREF)

5030218

C3-cable: 2,5 meters, fits to IQAN-MC3
Black, key C (for inputs and VREF)

5030219

C4-cable: 2,5 meters, fits to IQAN-MC3
Black, key D (for outputs)

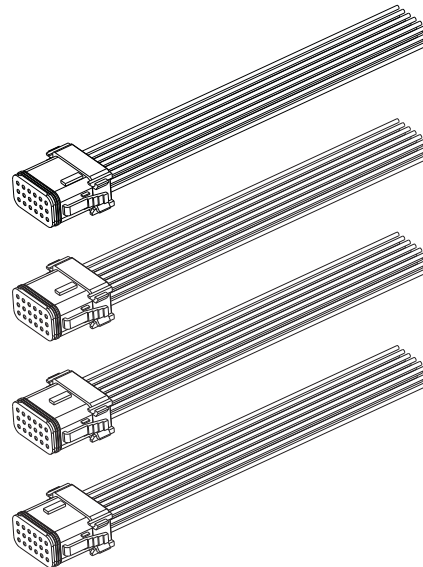

Communication cables

5030008

CAN-cable: 2,5 meters, fits to IQAN-XP, -XS

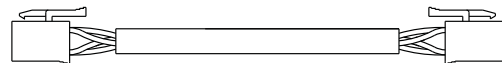

5030024

RS232-cable: 1,5 meters, fits to IQAN-MDM
(for PC connection to IQANdevelop, included in the IQANdevelop kit)

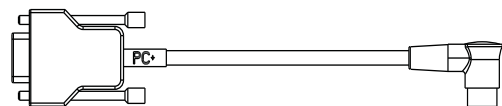

5030027

Lx-CAN/PWR: 2,5 meters, fits to IQAN-LL/LM
Lx-I/O: 1 meter, fits to IQAN-LL/LM

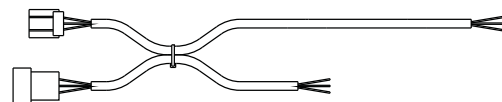

Communication cables

5030034

Interface-cable: for IQANsimulate
(included in the IQANdevelop Professional kit)

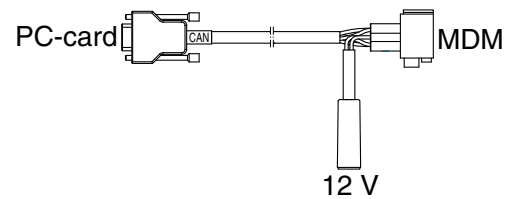

5030080

Remote diagnostics cable: 1,5 meters, fits to
IQAN-MDM (for modem)

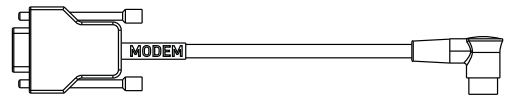

5030089

Panel mount serial adapter cable: 1 meter, fits to
IQAN-TOC2, -TOC8.
(Allows use of 5030024, and 5030080)

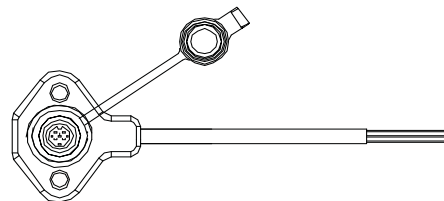

5030103

RS-232 cable: 1,5 meters, fits to IQAN-MDL2
(for connection to IQANdesign platform software)

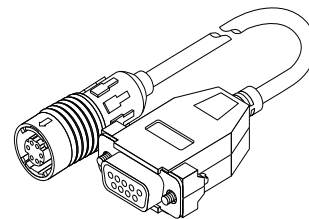

5030110

USB cable: 1,5 meters, fits to IQAN-MDL2
(for connection to IQANdesign platform software)

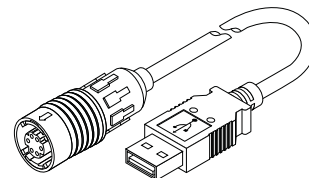

5030124

Panel mount USB adapter cable: 0,4 meter, fits to
IQAN-MC2, -MD3

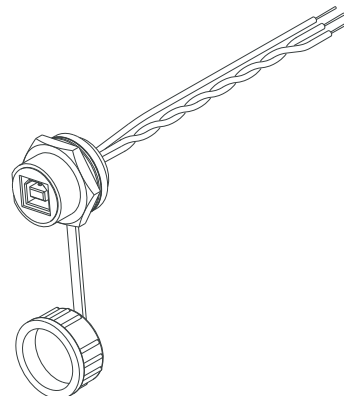

5030184

FAKRA to SMA antenna adapter cable: 0,2 meter,
fits to IQAN-G1

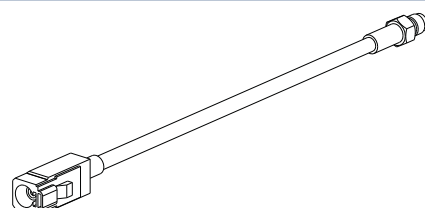

System cables

5030087
IQAN-TOC2 + 2x IQAN-LST or LSL (-S)
2,5 meters

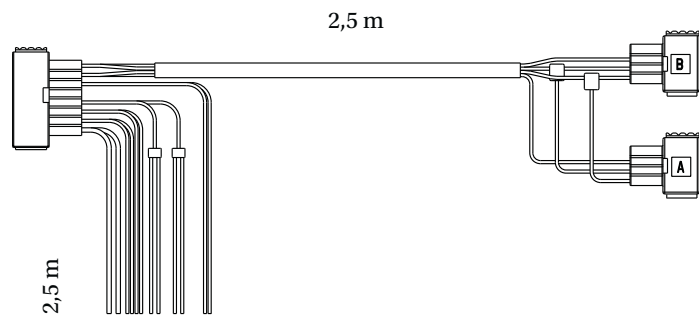

5030092
IQAN-TOC2 + 1x IQAN-LST or LSL (-S)
2,5 meters

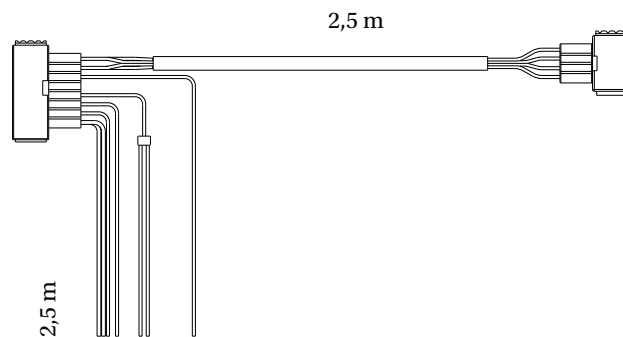

5030093 (phase-out)
IQAN-TOC2 + 1x ICL427
2,5 meters

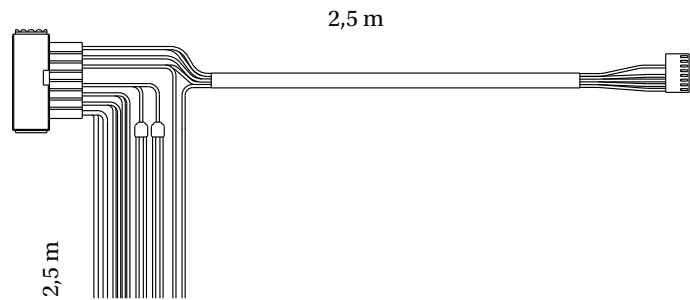

2830018
IQAN-LL to IQAN-LC5-C02
adapter cable, for replacing -LL
joysticks with -LC5-C02 joystcks
in existing installations
0,3 meters

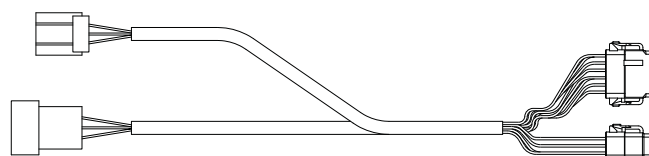

Address and termination

Id-Tag (Address units) AMP/Tyco terminals

Fits to IQAN-Lx, -XP2, -XT2, -XA2, -XS2

ordered in 10-pack only, use Ordering No.

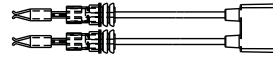

Address Id-Tags

Address	Part No.	Ordering No.	Resistance (ohms)
0	5030040	5030060	294
1	5030041	5030061	590
2	5030042	5030062	976
3	5030043	5030063	1.5K
4	5030044	5030064	2.23K
5	5030045	5030065	3.36K
6	5030046	5030066	5.3K
7	5030047	5030067	9.53K

Address with termination Id-Tags

Address	Part No.	Ordering No.	Resistance (ohms)
0T	5030050	5030070	432
1T	5030051	5030071	768
2T	5030052	5030072	1.21K
3T	5030053	5030073	1.82K
4T	5030054	5030074	2.74K
5T	5030055	5030075	4.17K
6T	5030056	5030076	6.9K
7T	5030057	5030077	14K

Termination unit

CAN Bus termination, fits to IQAN-XP, -XS

ordered in 10-pack only, use Ordering No.

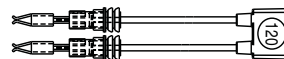

Termination Tag

Function	Part No.	Ordering No.	Resistance (ohms)
Termination	5030082	5030083	120

Address and termination

Id-Tag (Address units) Deutsch terminals

Fits to IQAN-LC5-C0x

ordered in 10-pack only, use Ordering No.



Address Id-Tags

Address	Part No.	Ordering No.	Resistance (ohms)
0	5030140	5030160	294
1	5030141	5030161	590
2	5030142	5030162	976
3	5030143	5030163	1.5K
4	5030144	5030164	2.23K
5	5030145	5030165	3.36K
6	5030146	5030166	5.3K
7	5030147	5030167	9.53K

Address with termination Id-Tags

Address	Part No.	Ordering No.	Resistance (ohms)
0T	5030150	5030170	432
1T	5030151	5030171	768
2T	5030152	5030172	1.21K
3T	5030153	5030173	1.82K
4T	5030154	5030174	2.74K
5T	5030155	5030175	4.17K
6T	5030156	5030176	6.9K
7T	5030157	5030177	14K

Termination unit

CAN Bus termination, fitted with Deutsch terminals

ordered in 10-pack only, use Ordering No.

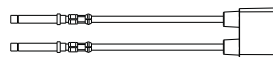

Termination Tag

Function	Part No.	Ordering No.	Resistance (ohms)
Termination	5030182	5030183	120

Connector kits

Includes all housings, contacts and seals for each unit.

Temperature sensor (old)

Part / Ordering No: **5031007**



Part	pcs.	AMP No.
Housing	1	963040-3
Contact JPT	2	929940-1
Seal JPT	2	828904-1

IQAN-X_2, -TOC8, -MDL2, -MC2

Part / Ordering No: **5031063**

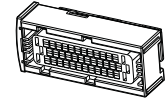

Part	pcs.	AMP No.
Housing	1	1-963226-1
Contact JPT	6	929929-1
Contact MT	36	963711-2
Seal JPT	6	828905-1
Seal MT	36	963530-1
Cover	1	962371-1

IQAN-XP, -XS CAN 1&2 (phase-out)

Part / Ordering No: **5031015**



Part	pcs.	AMP No.
Housing	1	929504-1
Contact JPT	12	929940-1
Housing	2	929504-2



IQAN-SP035, -SP500, -ST

Part / Ordering No: **5031086**



Part	pcs.	AMP No.
Housing	1	282191-1
Contact JPT	3	929940-1
Seal JPT	3	828904-1

IQAN-XP, -XS (phase-out)

Part / Ordering No: **5031016**



Part	pcs.	AMP No.
Housing	1	1-963226-1
Cover	1	962371-1
Contact JPT	17	927779-1
Contact MT	40	962945-2
Housing	2	929504-2



IQAN-TOC2

Part / Ordering No: **5031105**

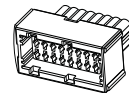

Part	pcs.	AMP No.
Housing	1	1-963217-1
Contact JPT	16	929940-1
Seal JPT	16	828904-1

IQAN-MDM, -LF1

Part / Ordering No: **5031022**



Part	pcs.	AMP No.
Housing	1	1-963212-1
Contact JPT	6	929940-1
Seal JPT	6	828904-1
Cavity plug	1	828922-1

IQAN-TOC2 system (phase-out)

IQAN-TOC2, 2x IQAN-LSL, 1x ICL4

Part / Ordering No: **5031124**

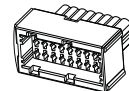

Part	pcs.	Parker No.
Conn. kit	1	5031105
Conn. kit	2	5031097
Conn. kit	1	5031125

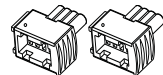

IQAN-LL, -LM (phase-out)

Part / Ordering No: **5031048**

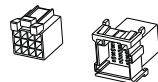

Part	pcs.	AMP No.
Housing	1	1-967622-1
Contact JPT	10	927779-1
Contact JPT	12	2-963745-1
Second lock	2	967632-1
Housing	1	1-967627-1

Connector kits

Includes all housings, contacts and seals for each unit.

IQAN-LSL, -LST (-S)

Part / Ordering No: **5031097**



Part	pcs.	AMP No.
Housing	1	1-963207-1
Contact JPT	4	929940-1
Seal JPT	4	828904-1

IQAN-LSL-E0-//-Lx (-S)

IQAN-LSL-E1-//-// (-S)

(switch or detent options)

Part / Ordering No: **5031098**



Part	pcs.	AMP No.
Housing	1	1-963210-1
Contact JPT	2	929940-1
Seal JPT	2	828904-1

IQAN-LSL, -LST (-D)

Part / Ordering No: **5031113**

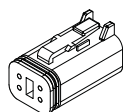

Part	pcs.	Deutsch No.
Housing	1	DT06-4S-C015
Wedge	1	W4S-P012
Contact	4	1062-16-0122

IQAN-LSL-E0-//-Lx (-D)

IQAN-LSL-E1-//-// (-D)

(switch or detent option)

Part / Ordering No: **5035014**

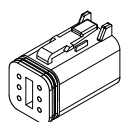

Part	pcs.	Deutsch No.
Housing	1	DT06-6S-CE06
Wedge	1	W6S-P012
Contact	6	1062-16-0122

IQAN-LSL-E1-//-Lx (-D)

(switch and detent options)

Part / Ordering No: **5035015**

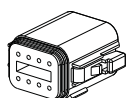

Part	pcs.	Deutsch No.
Housing	1	DT06-08SA-CE06
Wedge	1	W8S-P012
Contact	8	1062-16-0122

IQAN-MD3, C1 & C2, grey & black

Part / Ordering No: **20073081**

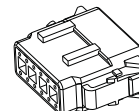

Part	pcs.	Deutsch No.
Housing	1	DTM06-12SA
Housing	1	DTM06-12SB
Wedge	2	WM12S
Contact	24	1062-20-0222
Sealing plug	24	0413-204-2005

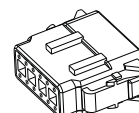

IQAN-G1, C1

Part / Ordering No: **20072406**

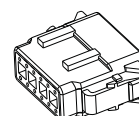

Part	pcs.	Deutsch No.
Housing	1	DTM06-12SA
Wedge	1	WM12S
Contact	12	1062-20-0222
Sealing plug	12	0413-204-2005

IQAN-LC5-X05, C1

IQAN-LC5-C0x, C1 or C3

Sensors: RS60, RS70, ATS90

Part / Ordering No: **20072408**

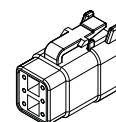

Part	pcs.	Deutsch No.
Housing	1	DTM06-6S
Wedge	1	WM6S
Contact	6	1062-20-0222
Sealing plug	6	0413-204-2005

IQAN-LC5-C0x, C1, C2 & C3

Part / Ordering No: **5035007**

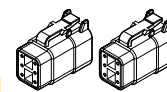

Part	pcs.	Deutsch No.
Housing	2	DTM06-6S
Wedge	2	WM6S
Housing	1	DTM06-12SA
Wedge	1	WM12S
Contact	24	1062-20-0222
Sealing plug	24	0413-204-2005

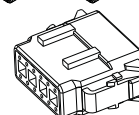

Connector kits

Includes all housings, contacts and seals for each unit.

Sensors: FP2000, FP3000, RM50
Part / Ordering No: **5035010**

Part	pcs.	Deutsch No.
Housing	1	DTM06-2S
Wedge	1	WM2S
Contact	2	1062-20-0222

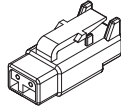

IQAN-LC5-X05-MP handle, 6 position
Part / Ordering No: **5035017**

Part	pcs.	Deutsch No.
Housing	1	DTM04-6P
Wedge	1	WM6P
Contact	6	1060-20-0222
Sealing plug	6	0413-204-2005

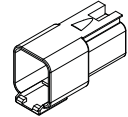

Sensors: RF50, RS49, RS52, RS53,
GS50, GS60, ATS50, ADS50, ACC50
Part / Ordering No: **5035011**

Part	pcs.	Deutsch No.
Housing	1	DTM06-3S
Wedge	1	WM3S
Contact	3	1062-20-0222

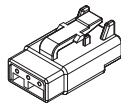

IQAN-LC5-X05-MP handle, 12 position
Part / Ordering No: **5035018**

Part	pcs.	Deutsch No.
Housing	1	DTM04-12PA
Wedge	1	WM12P
Contact	12	1060-20-0222
Sealing plug	12	0413-204-2005

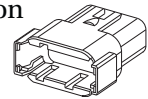

Sensors: FP4000
Part / Ordering No: **5035012**

Part	pcs.	Deutsch No.
Housing	1	DTM06-4S
Wedge	1	WM4S
Contact	4	1062-20-0222
Sealing plug	1	0413-204-2005

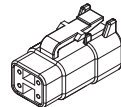

IQAN-MC3, C1-C4
Part / Ordering No: **5035016**

Part	pcs.	Deutsch No.
Housing	1	DT16-18SA
Housing	1	DT16-18SB
Housing	1	DT16-18SC
Housing	1	DT16-18SD
Contact	72	1062-16-0122
Sealing plug	24	114017

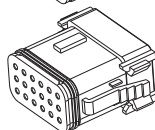
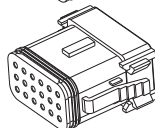
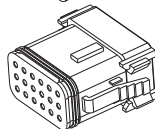
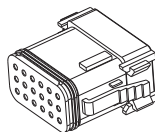

Crimping tools

5031061

IQAN tool kit

Consists of	use	Color	Part No.
Crimp tool	JPT* no seal	Yellow	5031049 ¹⁾
Crimp tool	JPT* with seal	Red	5031050 ¹⁾
Crimp tool	MT** seal/no seal	Blue	5031051 ¹⁾
Extraction tool kit	All types	All	5035003 ²⁾
Pin box	Spare parts	All	5031057 ²⁾

* Junior Power Timer

** Micro Timer

¹⁾Not available as separate items, only part of IQAN tool kit

²⁾Available as separate item



5035003

Extraction tool kit, included in IQAN tool kit

Consists of	use	Color	Part No.
Extraction tool	JPT*	Yellow	5031053 ¹⁾
Extraction tool	JPT* (for single latch CAN or Sensor connectors)	Red	5031054 ¹⁾
Extraction tool	MT**	Blue	5031055 ¹⁾

* Junior Power Timer

** Micro Timer

¹⁾Not available as separate items, only part of Extraction tool kit



5031057

Pin box, included in IQAN tool kit

Includes pin	Wire size	pcs.	AMP No.
JPT* no seal	0.75 mm ² (18 AWG)	50	927779-1 ¹⁾
JPT* no seal	1.5 mm ² (14 AWG)	25	927777-1 ¹⁾
JPT* with seal	0.75 mm ² (18 AWG)	50	929940-1 ¹⁾
JPT* with seal	1.5 mm ² (14 AWG)	25	929938-1 ¹⁾
JPT* with seal	0.75 mm ² (18 AWG)	25	2-963745-1 ¹⁾
JPT* seal	0.75 mm ² (18 AWG)	50	828904-1 ¹⁾
JPT* seal	1.5 mm ² (14 AWG)	25	828905-1 ¹⁾
JPT* cavity sealing plug	n/a	25	828922-1 ¹⁾
MT** no seal	0.75 mm ² (18 AWG)	100	962945-2 ¹⁾
MT** with seal	0.75 mm ² (18 AWG)	100	963711-2 ¹⁾
MT** seal	0.75 mm ² (18 AWG)	100	963530-1 ¹⁾
MT** cavity sealing plug	n/a	100	963531-1 ¹⁾

* Junior Power Timer

** Micro Timer

¹⁾Not available as separate items, only part of Pin box



Software

IQANdevelop platform

Contents: software package	Part no. 20005604 Read	Part no. 2005606 Change	Part no. 2004179 Develop	Part no. 20005607 PRO	contents: part no.
software CD	x	x	x	x	
software licence no.	x	x	x	x	
serial cable for -MDM	x	x	x	x	5030024
IQANsimulate software				x	
IQANsimulate cable				x	5030034

Software IQANdevelop Read is also available in a version without licence no. from www.iqan.com.
Printed user manual is not included. Please contact Parker Catalogue Services.

IQANdesign platform IQAN Studio softwares

Contents: software package	Part no. 20073643 IQAN Creative Studio	Part no. 20073644 IQAN Productive Studio	Part no. 20073642 IQAN Active Studio
software CD	x	x	x
software licence no.	x	x	x

Communication cables are not included. Please choose cables to fit your requirements from page 3.
Printed user manuals are not included. Please contact Parker Catalogue Services.

IQAN software user manual cross-reference

IQAN software package	IQAN Creative Studio	IQAN Productive Studio	IQAN Active Studio	IQANdevelop software
User manual publication no.	HY17-8396/UK	HY17-8397/UK	HY17-8398/UK	HY17-8336/UK

WARNING

FAILURE OR IMPROPER SELECTION OR IMPROPER USE OF THE PRODUCTS AND/OR SYSTEMS DESCRIBED HEREIN OR RELATED ITEMS CAN CAUSE DEATH, PERSONAL INJURY AND PROPERTY DAMAGE.

This document and other information from Parker Hannifin Corporation, its subsidiaries and authorized distributors provide product and/or system options for further investigation by users having technical expertise. It is important that you analyze all aspects of your application, including consequences of any failure, and review the information concerning the product or system in the current product catalogue. Due to the variety of operating conditions and applications for these products or systems, the user, through its own analysis and testing, is solely responsible for making the final selection of the products and systems and assuring that all performance, safety and warning requirements of the application are met.

The products described herein, including without limitation, product features, specifications, designs, availability and pricing, are subject to change by Parker Hannifin Corporation and its subsidiaries at any time without notice.

Offer of Sale

Please contact your Parker representation for a detailed "Offer of Sale".

Parker Worldwide

Europe, Middle East, Africa

AE – United Arab Emirates,
Dubai

Tel: +971 4 8127100
parker.me@parker.com

AT – Austria, Wiener Neustadt

Tel: +43 (0)2622 23501-0
parker.austria@parker.com

AT – Eastern Europe, Wiener
Neustadt

Tel: +43 (0)2622 23501 900
parker.easteurope@parker.com

AZ – Azerbaijan, Baku

Tel: +994 50 2233 458
parker.azerbaijan@parker.com

BE/LU – Belgium, Nivelles

Tel: +32 (0)67 280 900
parker.belgium@parker.com

BY – Belarus, Minsk

Tel: +375 17 209 9399
parker.belarus@parker.com

CH – Switzerland, Etoy

Tel: +41 (0)21 821 87 00
parker.switzerland@parker.com

CZ – Czech Republic, Klecany

Tel: +420 284 083 111
parker.czechrepublic@parker.com

DE – Germany, Kaarst

Tel: +49 (0)2131 4016 0
parker.germany@parker.com

DK – Denmark, Ballerup

Tel: +45 43 56 04 00
parker.denmark@parker.com

ES – Spain, Madrid

Tel: +34 902 330 001
parker.spain@parker.com

FI – Finland, Vantaa

Tel: +358 (0)20 753 2500
parker.finland@parker.com

FR – France, Contamine s/Arve

Tel: +33 (0)4 50 25 80 25
parker.france@parker.com

GR – Greece, Athens

Tel: +30 210 933 6450
parker.greece@parker.com

HU – Hungary, Budapest

Tel: +36 1 220 4155
parker.hungary@parker.com

IE – Ireland, Dublin

Tel: +353 (0)1 466 6370
parker.ireland@parker.com

IT – Italy, Corsico (MI)

Tel: +39 02 45 19 21
parker.italy@parker.com

KZ – Kazakhstan, Almaty

Tel: +7 7272 505 800
parker.easteurope@parker.com

NL – The Netherlands, Oldenzaal

Tel: +31 (0)541 585 000
parker.nl@parker.com

NO – Norway, Asker

Tel: +47 66 75 34 00
parker.norway@parker.com

PL – Poland, Warsaw

Tel: +48 (0)22 573 24 00
parker.poland@parker.com

PT – Portugal, Leca da Palmeira

Tel: +351 22 999 7360
parker.portugal@parker.com

RO – Romania, Bucharest

Tel: +40 21 252 1382
parker.romania@parker.com

RU – Russia, Moscow

Tel: +7 495 645-2156
parker.russia@parker.com

SE – Sweden, Spånga

Tel: +46 (0)8 59 79 50 00
parker.sweden@parker.com

SK – Slovakia, Banská Bystrica

Tel: +421 484 162 252
parker.slovakia@parker.com

SL – Slovenia, Novo Mesto

Tel: +386 7 337 6650
parker.slovenia@parker.com

TR – Turkey, Istanbul

Tel: +90 216 4997081
parker.turkey@parker.com

UA – Ukraine, Kiev

Tel +380 44 494 2731
parker.ukraine@parker.com

UK – United Kingdom, Warwick

Tel: +44 (0)1926 317 878
parker.uk@parker.com

ZA – South Africa, Kempton Park

Tel: +27 (0)11 961 0700
parker.southafrica@parker.com

North America

CA – Canada, Milton, Ontario

Tel: +1 905 693 3000

US – USA, Cleveland

(industrial)
Tel: +1 216 896 3000

US – USA, Elk Grove Village

(mobile)
Tel: +1 847 258 6200

Asia Pacific

AU – Australia, Castle Hill

Tel: +61 (0)2-9634 7777

CN – China, Shanghai

Tel: +86 21 2899 5000

HK – Hong Kong

Tel: +852 2428 8008

IN – India, Mumbai

Tel: +91 22 6513 7081-85

JP – Japan, Fujisawa

Tel: +81 (0)4 6635 3050

KR – South Korea, Seoul

Tel: +82 2 559 0400

MY – Malaysia, Shah Alam

Tel: +60 3 7849 0800

NZ – New Zealand, Mt Wellington

Tel: +64 9 574 1744

SG – Singapore

Tel: +65 6887 6300

TH – Thailand, Bangkok

Tel: +662 717 8140

TW – Taiwan, Taipei

Tel: +886 2 2298 8987

South America

AR – Argentina, Buenos Aires

Tel: +54 3327 44 4129

BR – Brazil, Cachoeirinha RS

Tel: +55 51 3470 9144

CL – Chile, Santiago

Tel: +56 2 623 1216

MX – Mexico, Apodaca

Tel: +52 81 8156 6000

European Product Information Centre

Free phone: 00 800 27 27 5374

(from AT, BE, CH, CZ, DE, DK, EE, ES, FI, FR, IE, IL,
IS, IT, LU, MT, NL, NO, PL, PT, RU, SE, SK, UK, ZA)

US Product Information Centre

Free phone: 1 800 272 7537

www.parker.com

